

This drawing remains property of Nivelco Control Co. it may be neither copied nor informed to third persons or competitors without our approval.

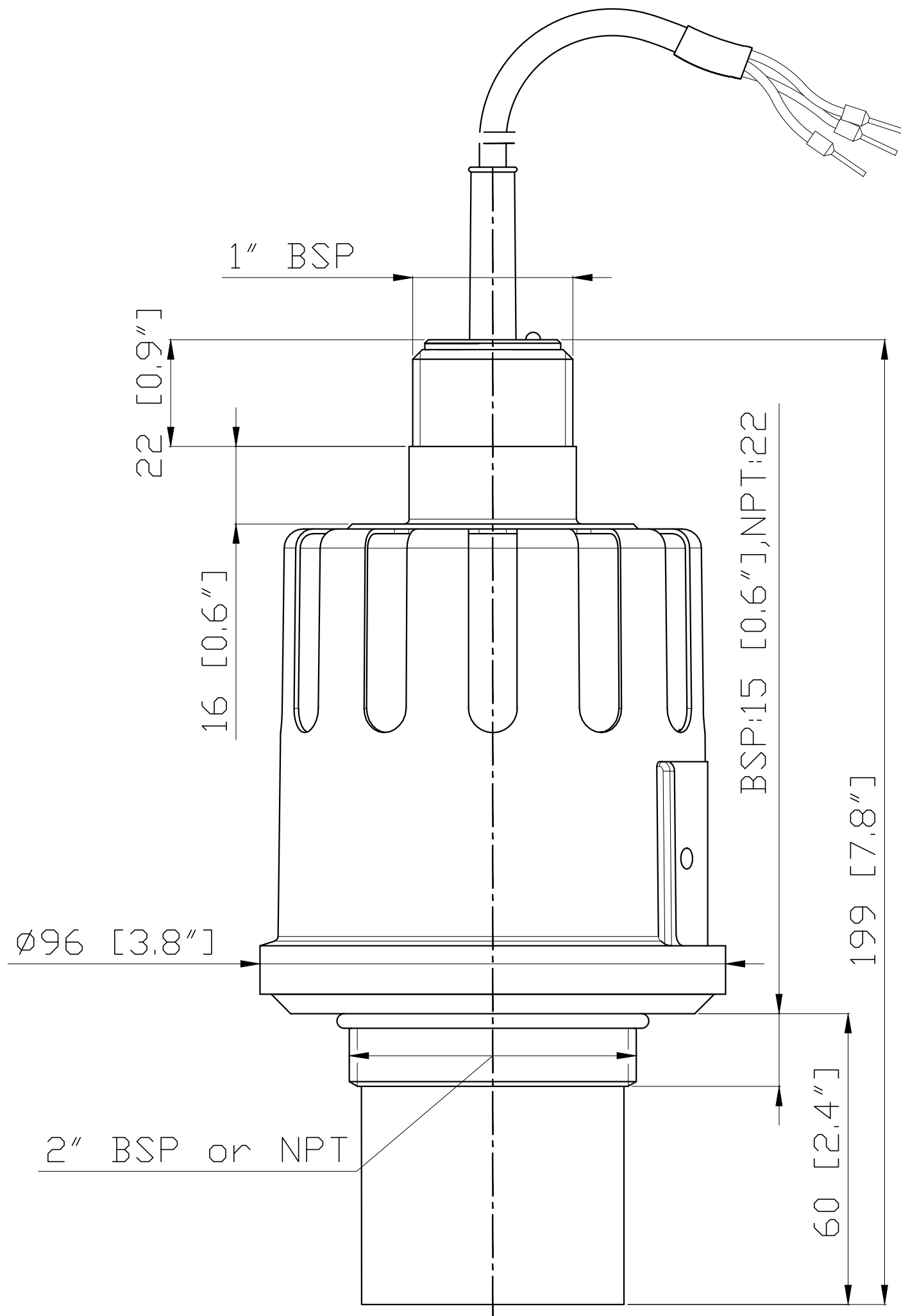

NIVELCO
 Process Control Co.
 H-1043 BUDAPEST,
 DUGONICS U. 11.
 www.nivelco.com

Description:
 EASYTREK SP-300
 Ultrasonic Level Transmitter
 Integrated version, 2" process conn.

Scale: 1:1	Size of origin: A3
Revision: 0	Date: 2014.07.01
Drawing No. SPA/SPB-38_	